

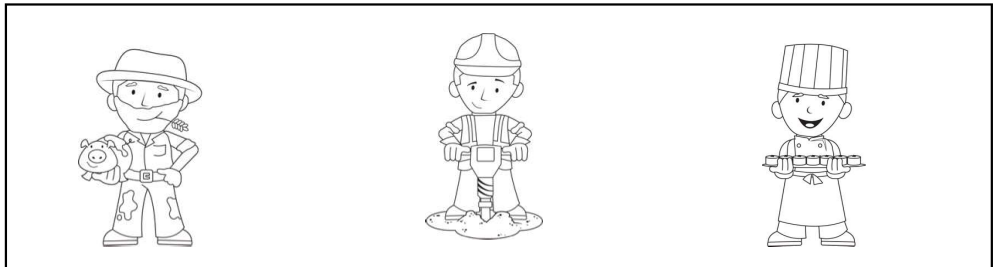

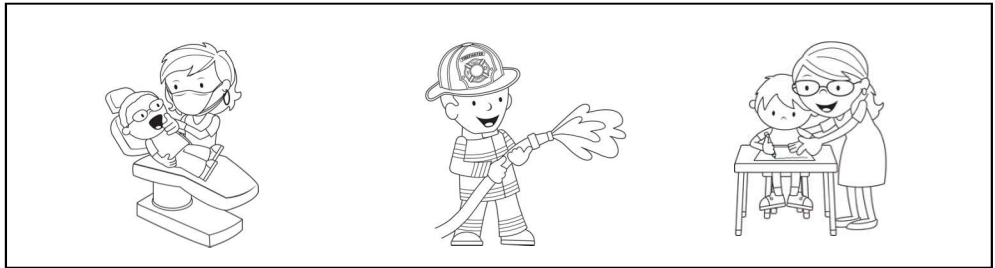

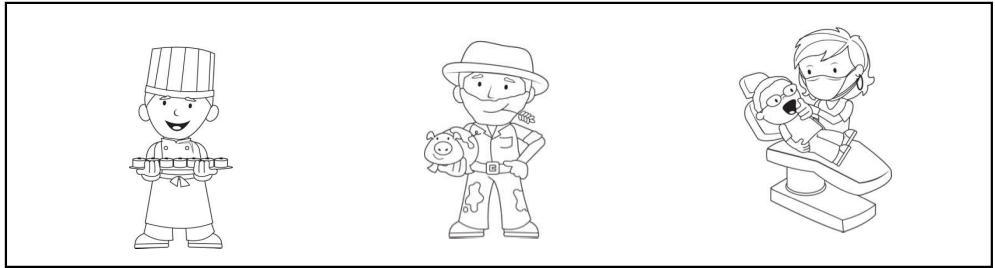

Circle the match:

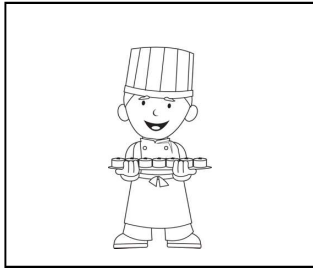

Write the name of the community helper:



Copy the words and color the pictures:

<p><b>chef</b></p> 	<p><b>police officer</b></p> 	<p><b>fire fighter</b></p> 
<p><b>teacher</b></p> 	<p><b>construction worker</b></p> 	<p><b>farmer</b></p> 

Color all the of the police officers:



Color all the of the chefs:

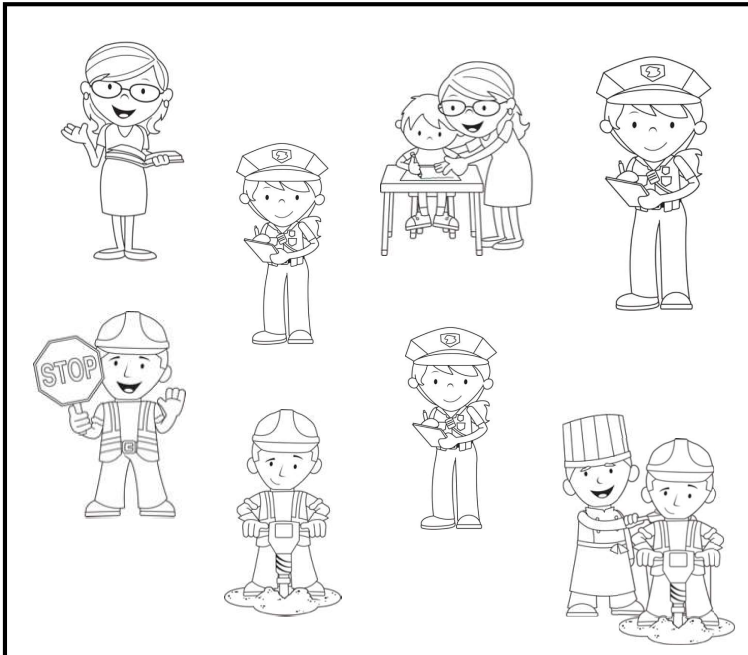
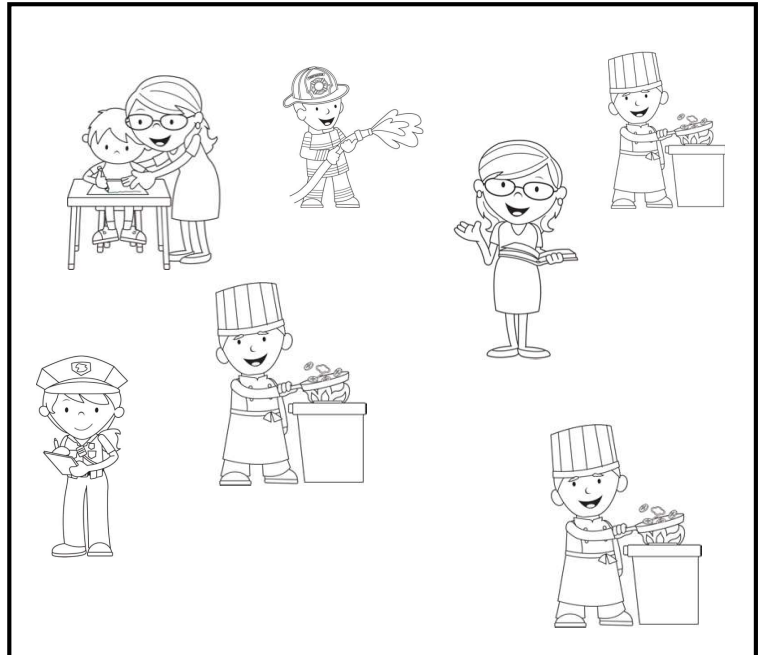

	
--	--

Match the pictures:

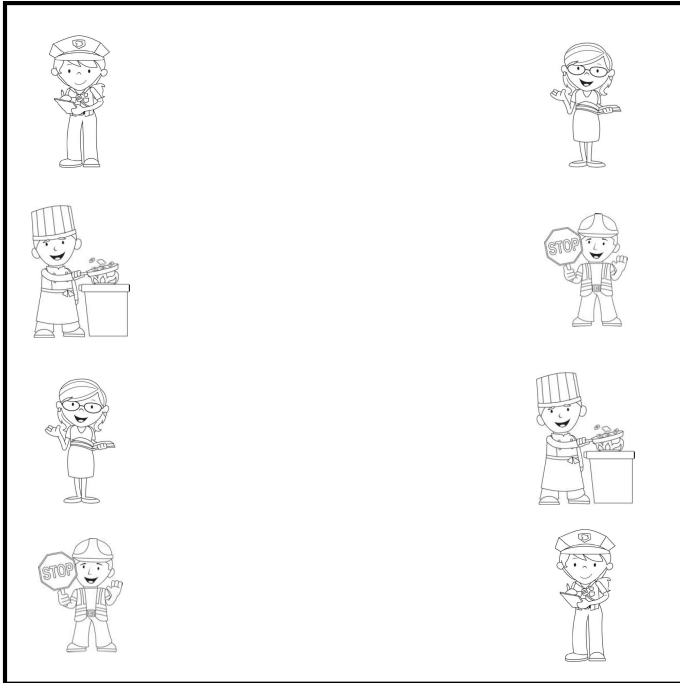

Write the words:



\_\_\_\_\_



\_\_\_\_\_



\_\_\_\_\_



\_\_\_\_\_



\_\_\_\_\_

chef



police officer



teacher



construction worker



fire fighter



Match the pictures:

Write **water**, **land**, or **air** under each set of items:

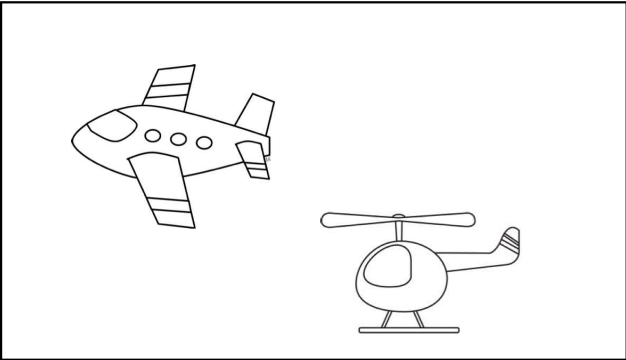
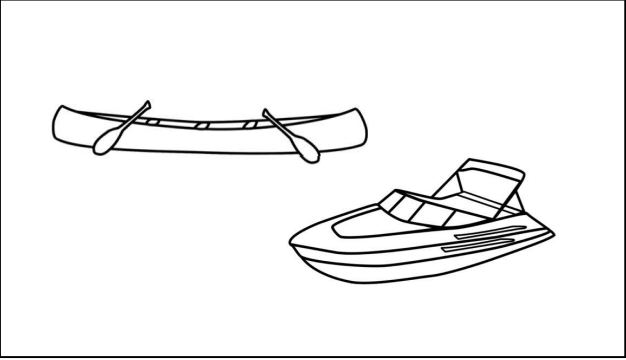
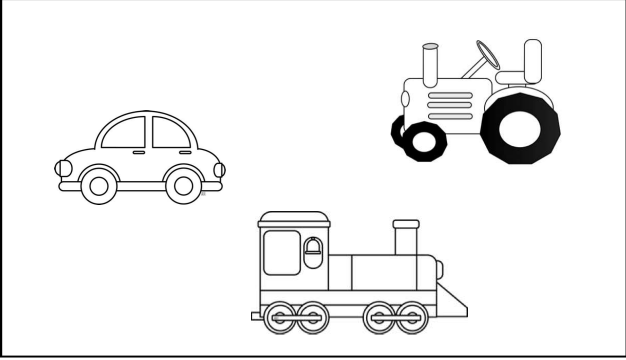
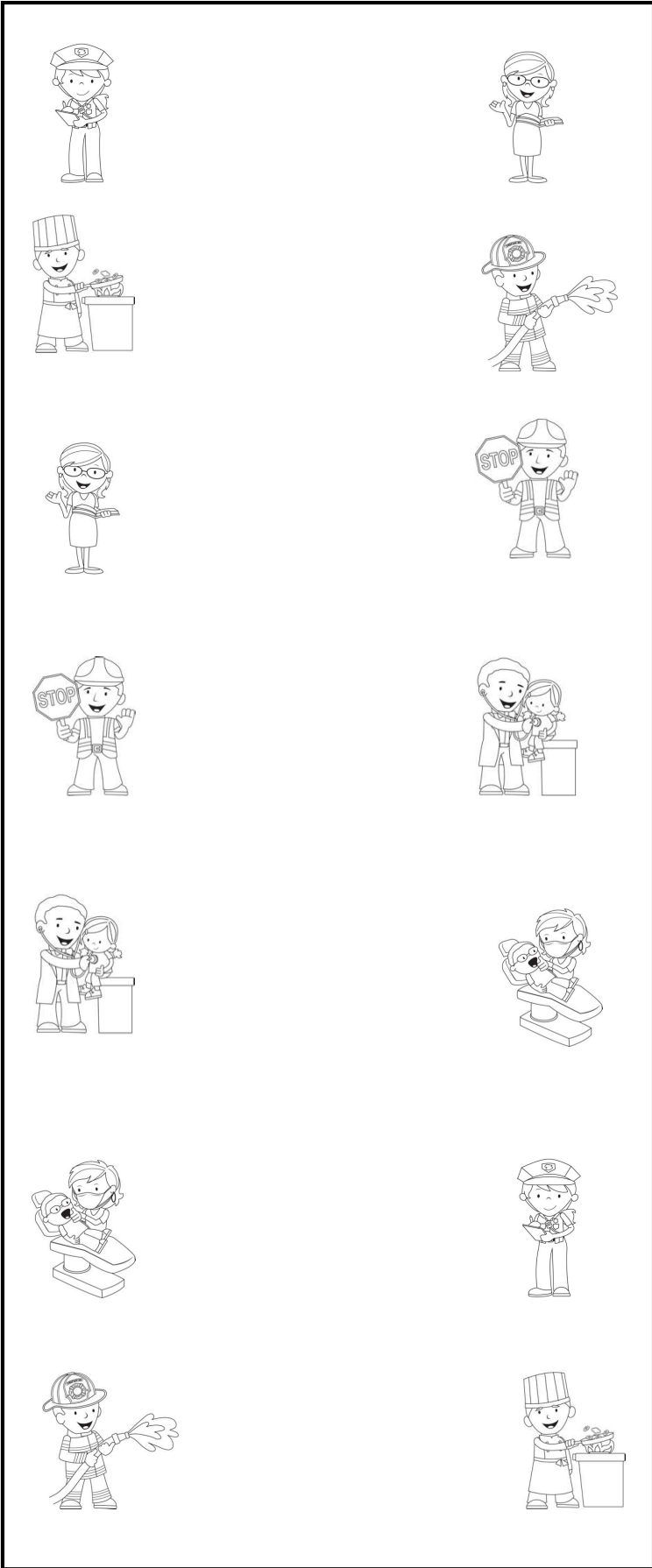

Color all the of the fire fighters:



Copy the name of each:

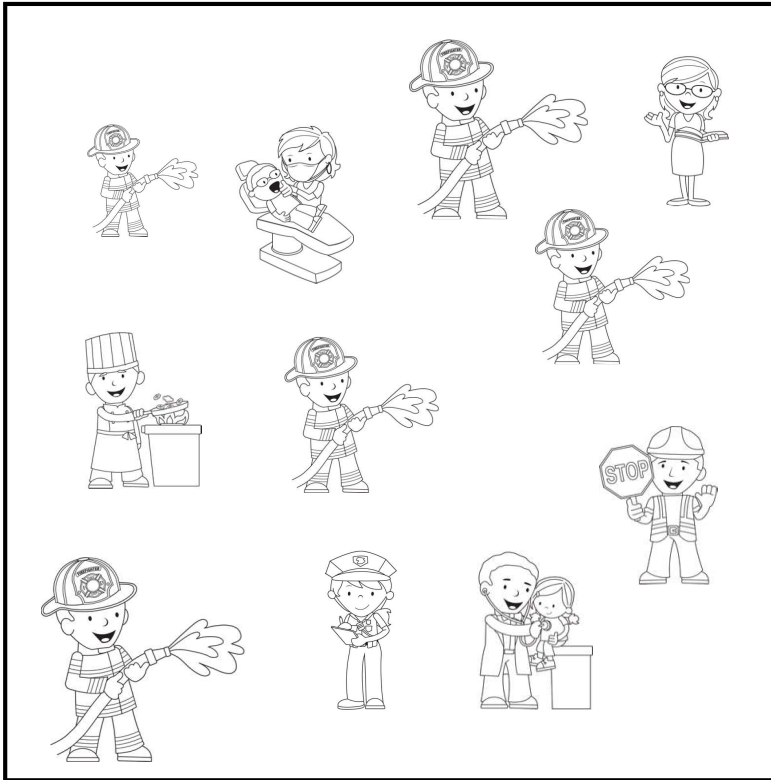

teacher: \_\_\_\_\_

chef: \_\_\_\_\_

doctor: \_\_\_\_\_

farmer: \_\_\_\_\_

Match the pictures:

Match the pictures:

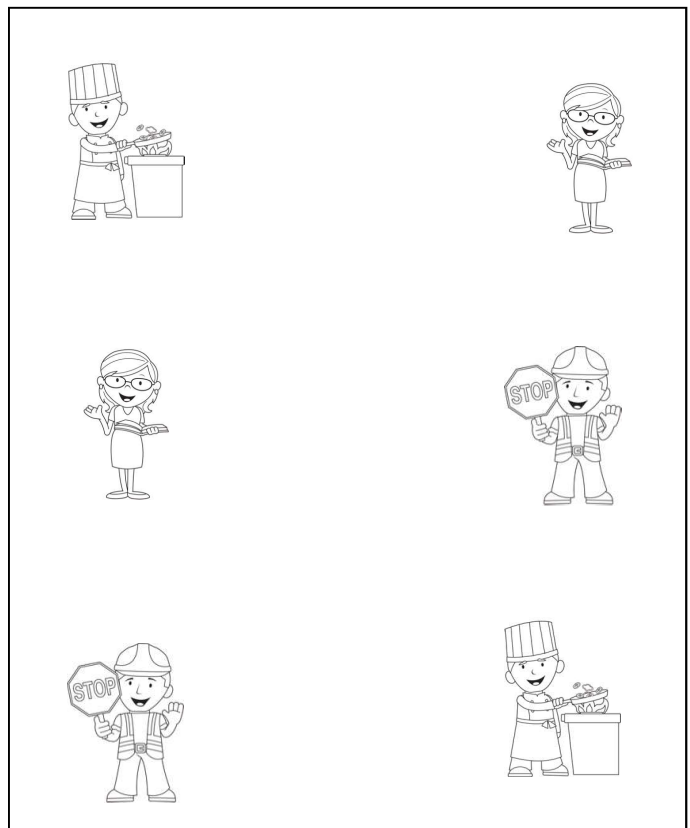
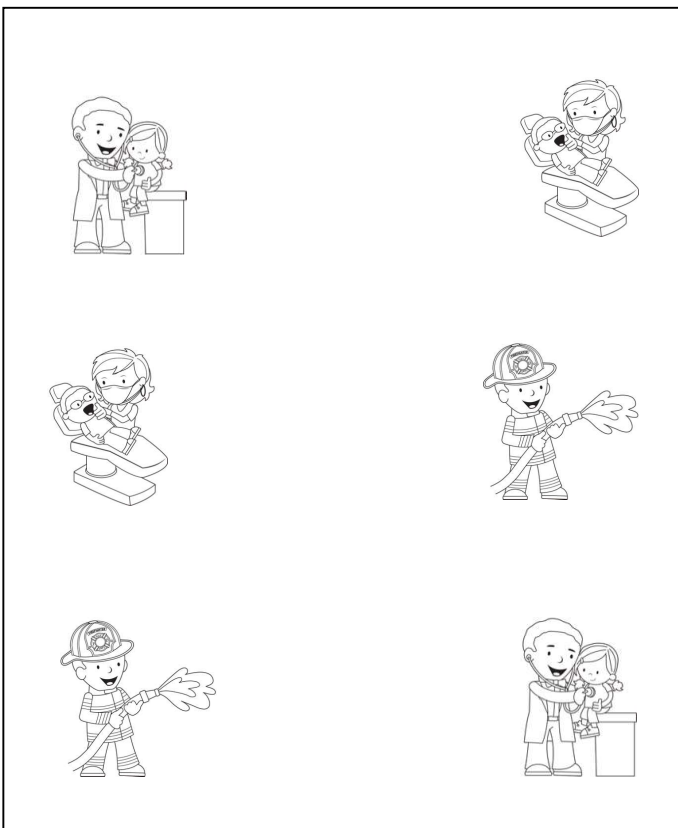

Circle the correct word:



farmer  
chef



chef  
doctor







police officer  
fire fighter



teacher  
dentist

Copy each word:

<p>teacher </p> <div data-bbox="175 1316 722 1509" style="border: 1px solid black; height: 92px; width: 337px;"></div>	<p>police officer </p> <div data-bbox="930 1308 1477 1501" style="border: 1px solid black; height: 92px; width: 337px;"></div>
<p>construction worker </p> <div data-bbox="175 1749 722 1942" style="border: 1px solid black; height: 92px; width: 337px;"></div>	<p>chef </p> <div data-bbox="930 1743 1477 1936" style="border: 1px solid black; height: 92px; width: 337px;"></div>

Circle the correct name of each item:



police officer    chef



doctor    chef



chef    dentist



farmer    chef





teacher    dentist



doctor    fire fighter

Color the chef **orange**:

Color the construction worker **green**:



Write the name of each:

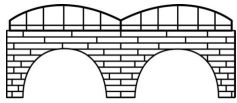
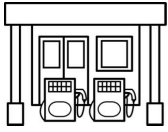

Copy each word:

**chef**



**farmer**



**doctor**



**dentist**







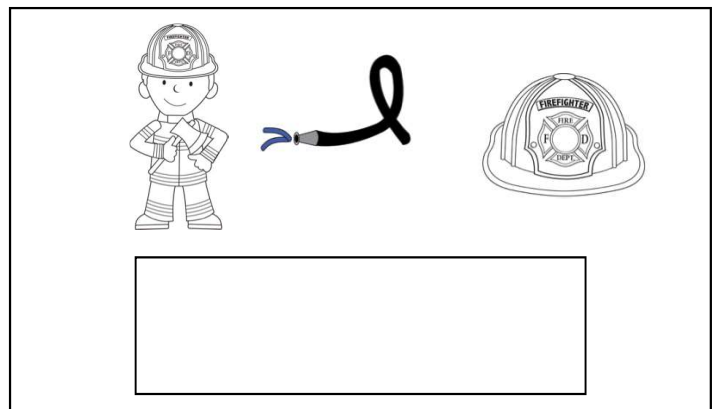
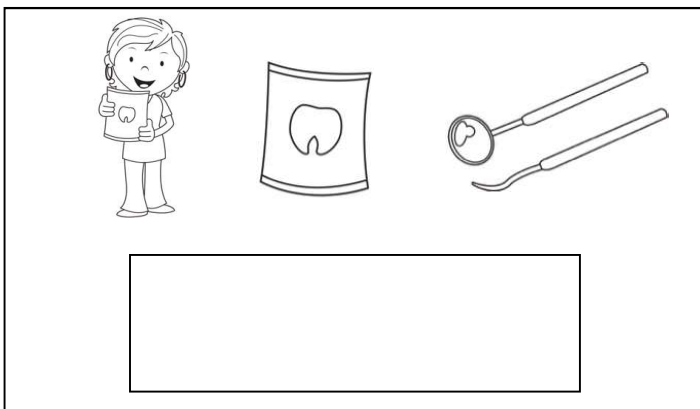
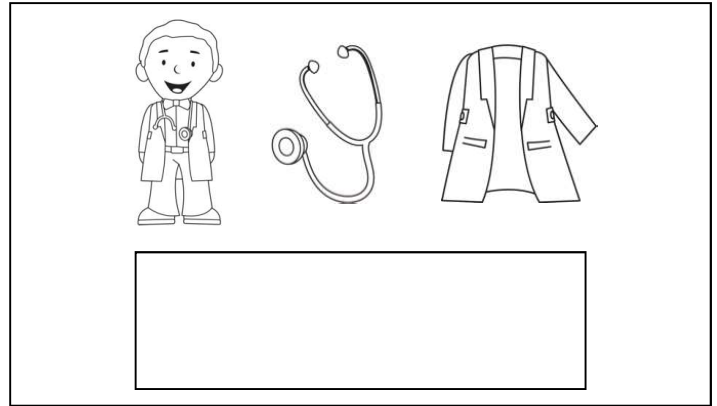
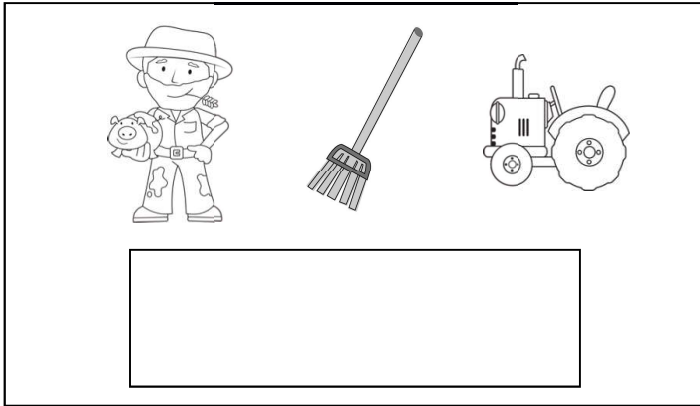

Write the community helper under each group of pictures:















Match the community helper to the word:

	<b>dentist</b>
	<b>police officer</b>
	<b>chef</b>
	<b>doctor</b>

	<b>fire fighter</b>
	<b>teacher</b>
	<b>construction worker</b>
	<b>farmer</b>

Match the community helper to something they use:

Match the community helper to something they use:

	chef
	doctor

	dentist
	chef

	teacher
	fire fighter

	fire fighter
	doctor

	construction worker
	dentist

	farmer
	teacher

Color the dentist blue;  
Color the fire fighter red;  
Color the chef yellow;  
Color the police officer green:



Color the items for each community helper:

What does a police officer need?

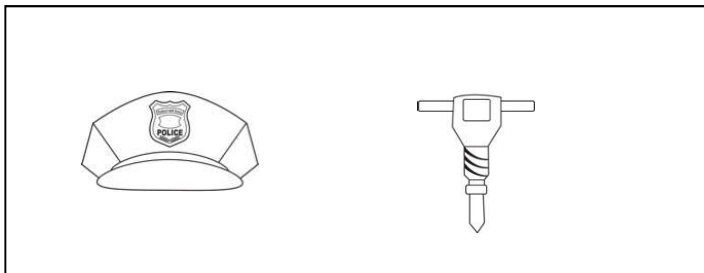

What does a doctor need?

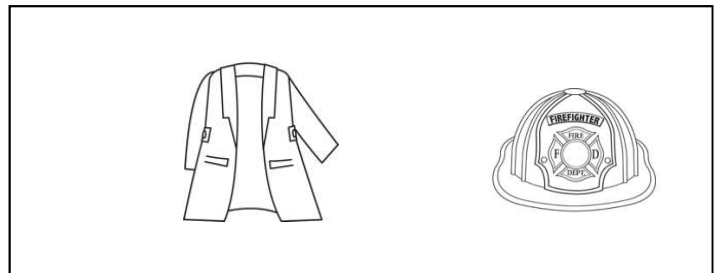



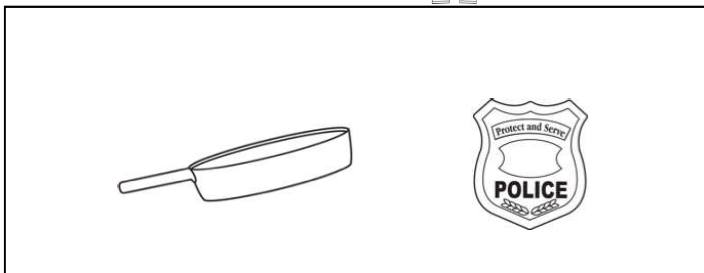

What does a chef need?

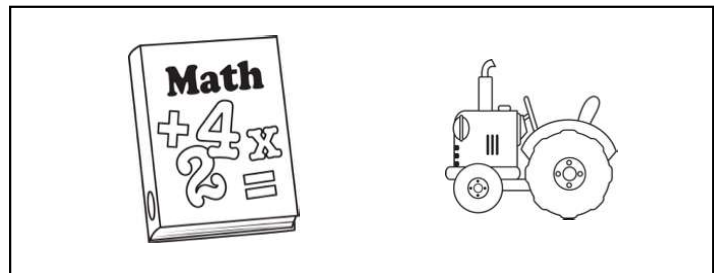



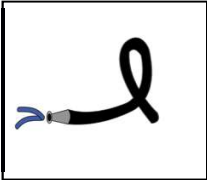

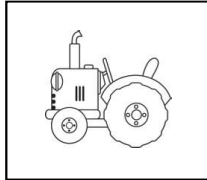
What does a farmer need?















What does each community helper use?

  	  	  
---	---	--

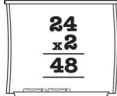





Color the match:

				
--	---	---	---	---

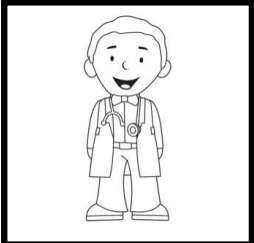
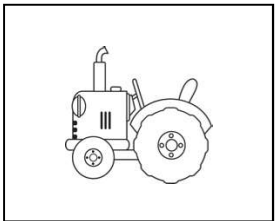
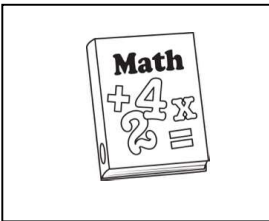
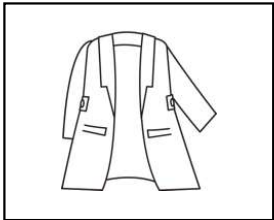

Match the community helper to something they use:

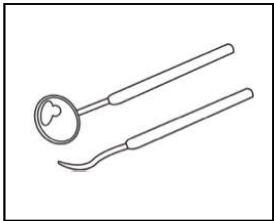

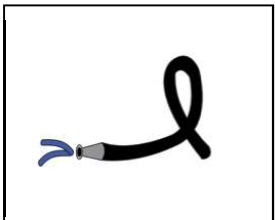
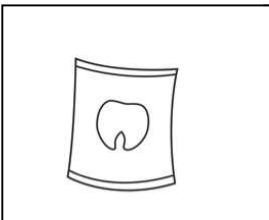
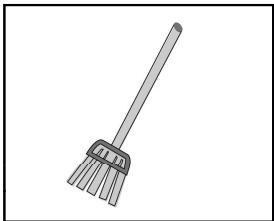

Circle the match of the association:

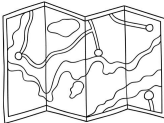

Write the words:

	_____
	_____
_____	_____
_____	_____
	_____

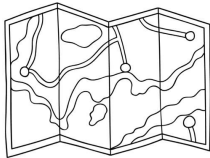
<b>globe</b>	
	<b>compass</b>
	
<b>map</b>	
	<b>street</b>
	_____
	_____

Circle the correct name of each item:



farmer    chef



teacher    dentist



doctor    fire fighter



police officer    chef











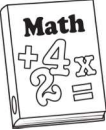

doctor    chef





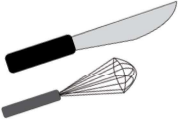







chef    dentist



Match the community helper to something they use:

Match the community helper to the word:

	doctor		dentist
	construction worker		construction worker
	police officer		doctor
	teacher		farmer
	chef		fire fighter

What does each community helper use?

Circle the two that go together:

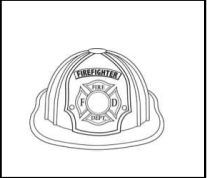
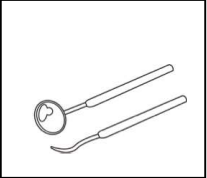
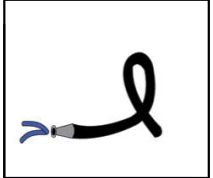
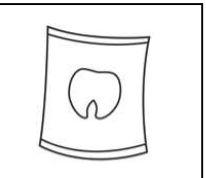
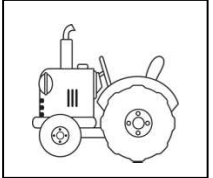
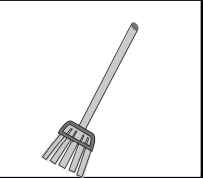

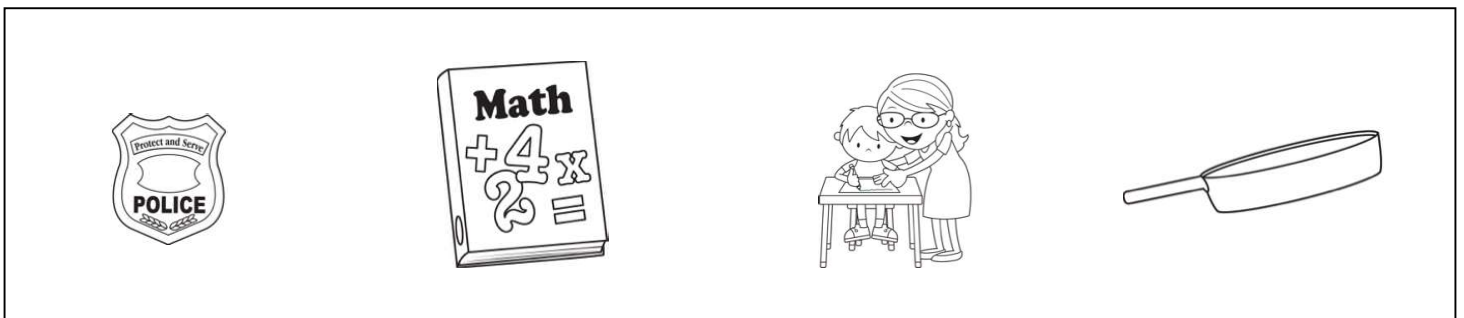
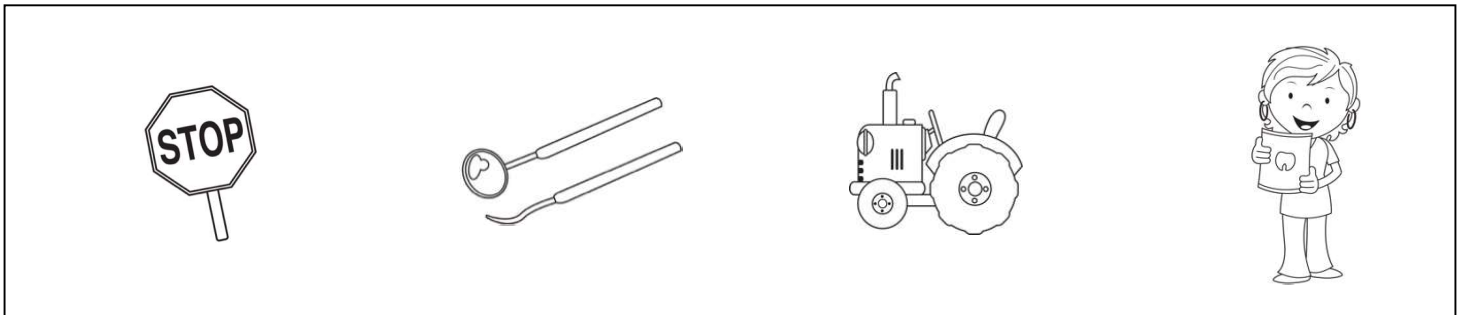
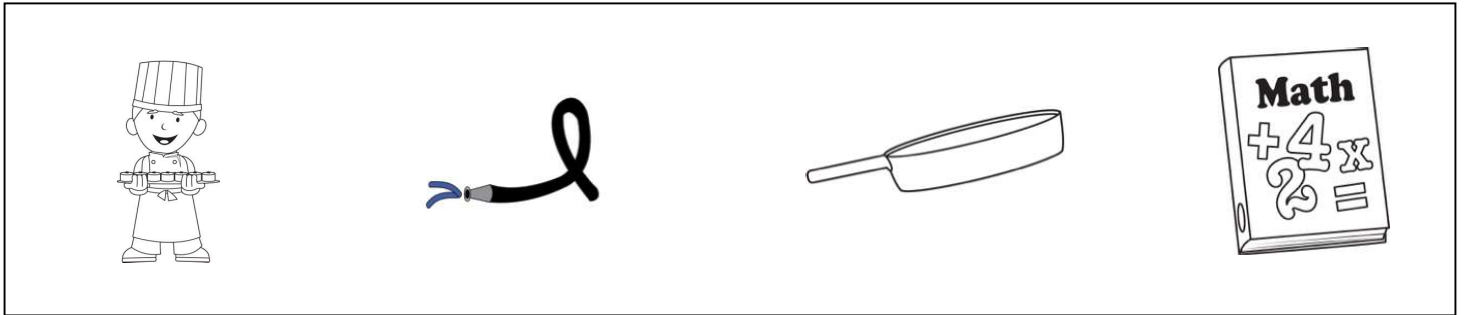
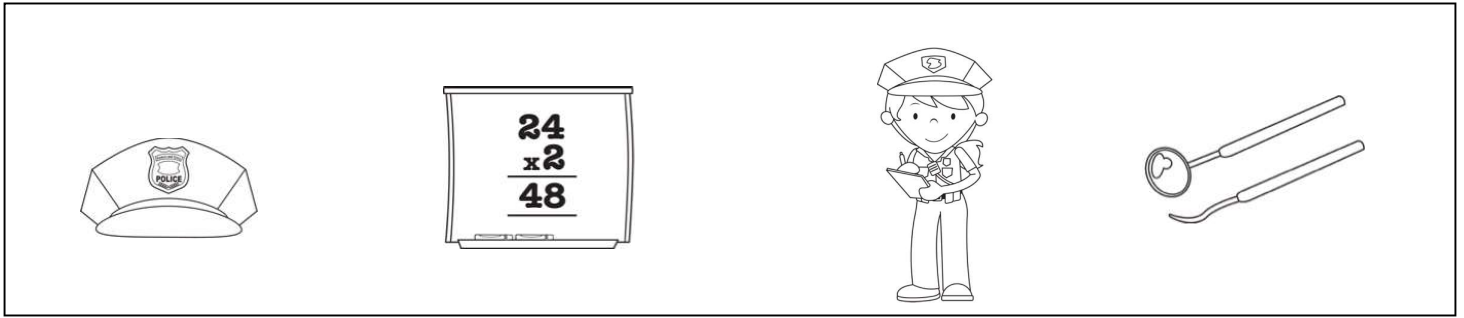
Color all the of the gas stations:



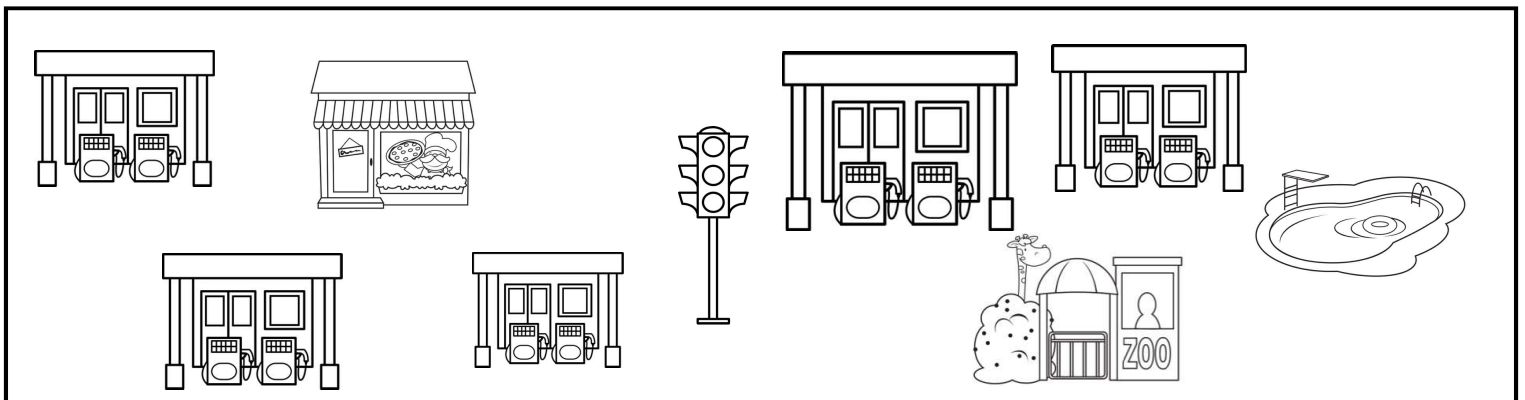
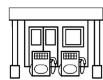

Color the items for each community helper:

What does a chef need?

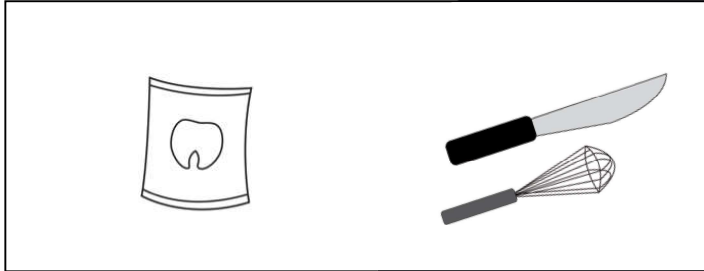

What does a dentist need?

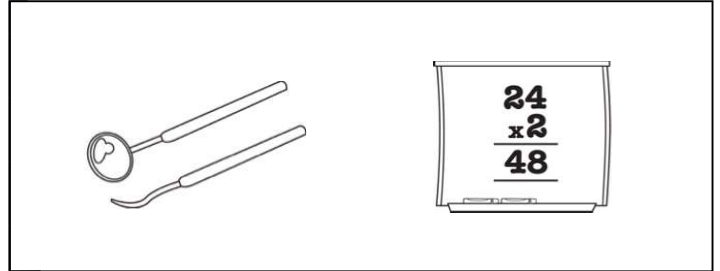

What does a teacher need?

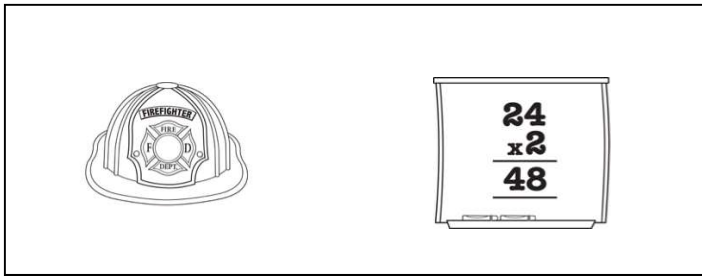

What does a fire fighter need?

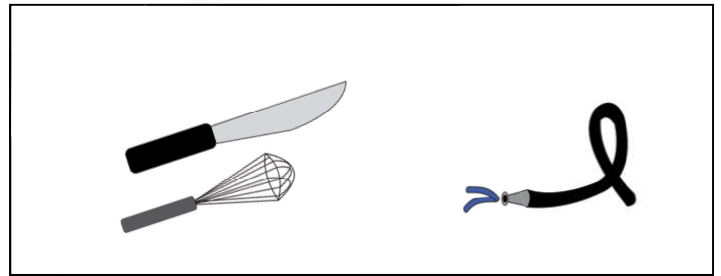

Color all the of the things a chef uses:

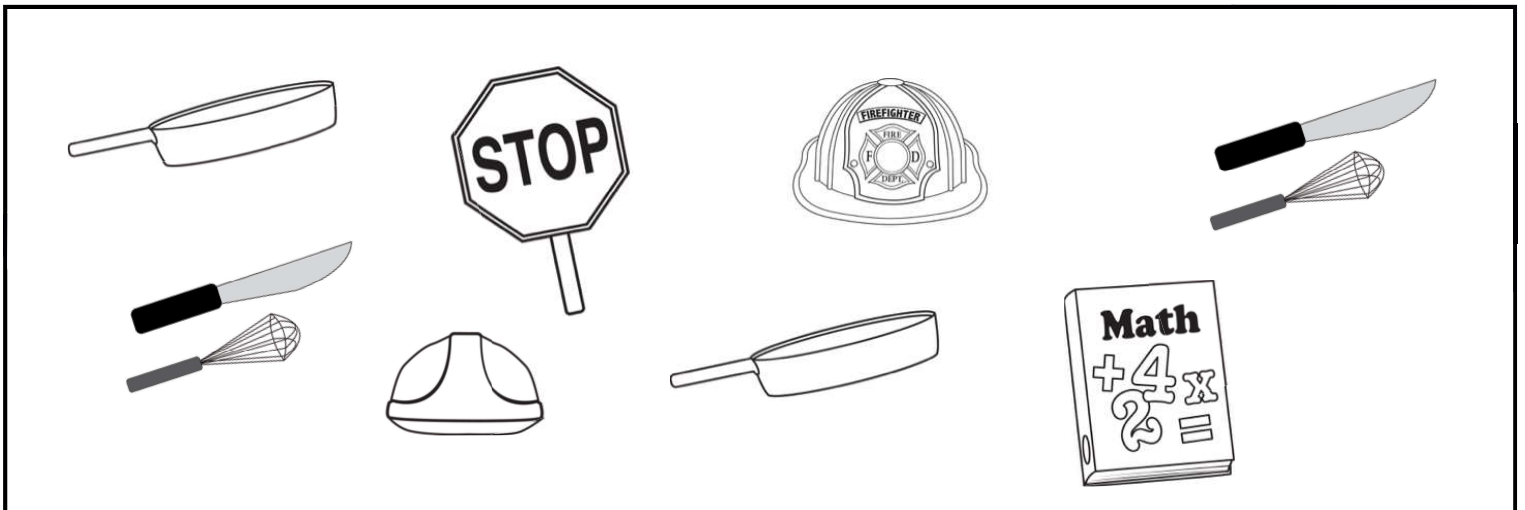

Copy the name of each:

teacher: \_\_\_\_\_

farmer: \_\_\_\_\_

Match the community helper to something they use:

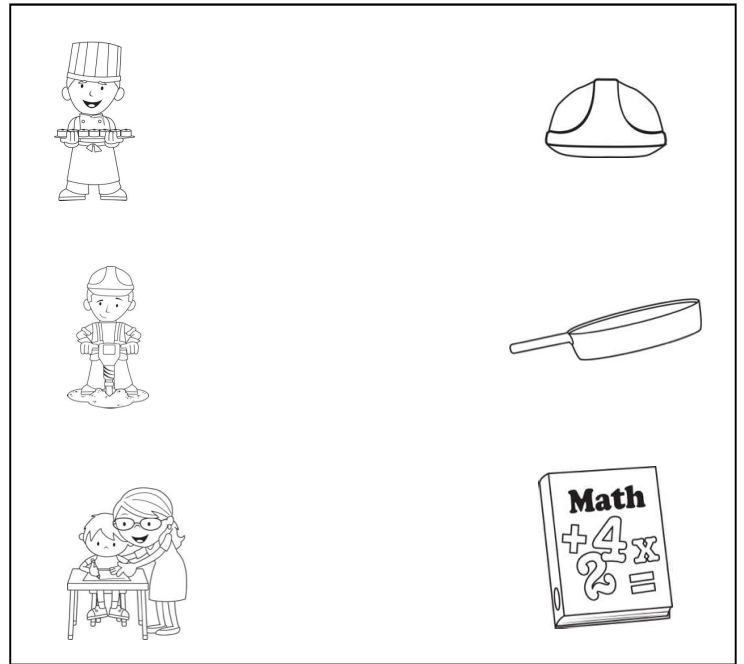
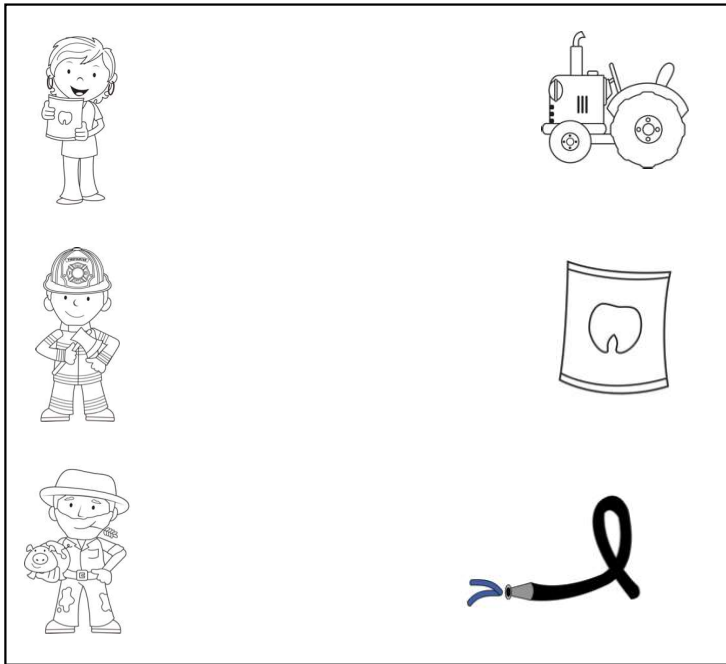

Circle the correct word:



doctor  
dentist



teacher  
fire fighter



teacher  
chef



police officer  
fire fighter



doctor  
farmer



construction worker  
doctor

Write the name of each:



Match the community helper to the word:



doctor



fire fighter



teacher



dentist



construction worker



chef











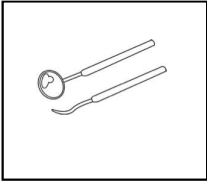
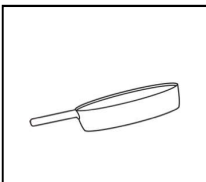

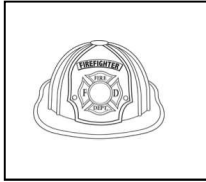
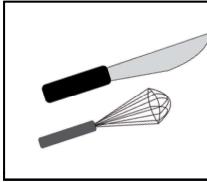
police officer

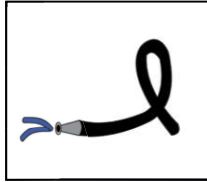
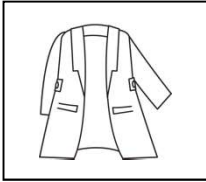

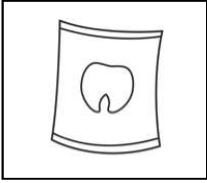
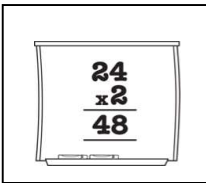
teacher

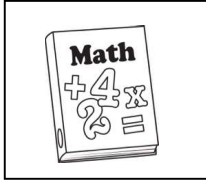
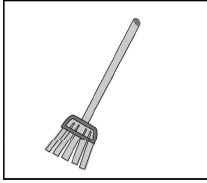
What does each community helper use?

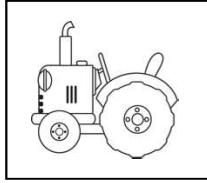
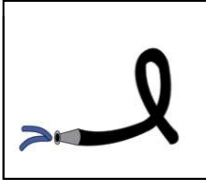
Circle the correct name of each item:



White House  
Washington, D.C.

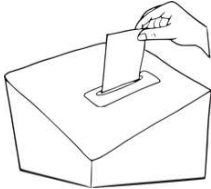

flag  
vote



Washington, D.C.  
White House