

Circle the match:

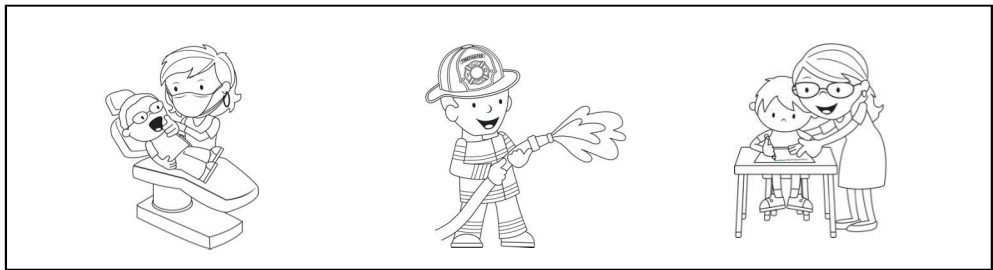

Write the name of the community helper:

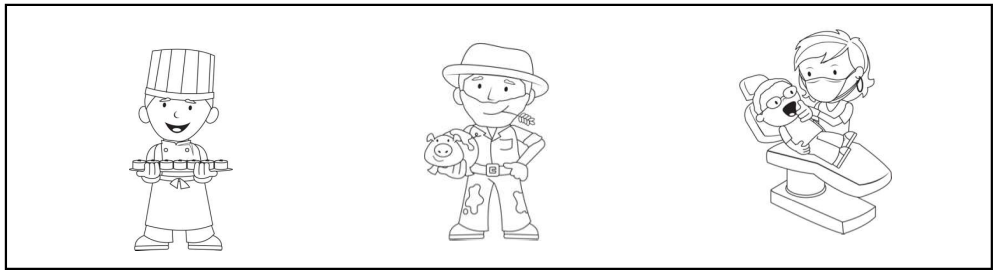
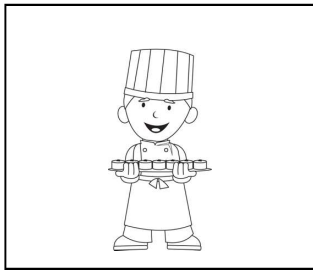

chef









dentsit



doctor

Copy the words and color the pictures:

<p><b>chef</b></p> <p>chef</p> 	<p><b>police officer</b></p> <p>police officer</p> 	<p><b>fire fighter</b></p> <p>fire fighter</p> 
--	--	--

<p><b>teacher</b></p> <p>teacher</p> 	<p><b>construction worker</b></p> <p>construction worker</p> 	<p><b>farmer</b></p> <p>farmer</p> 
--	--	--

Color all the of the police officers:



Color all the of the chefs:

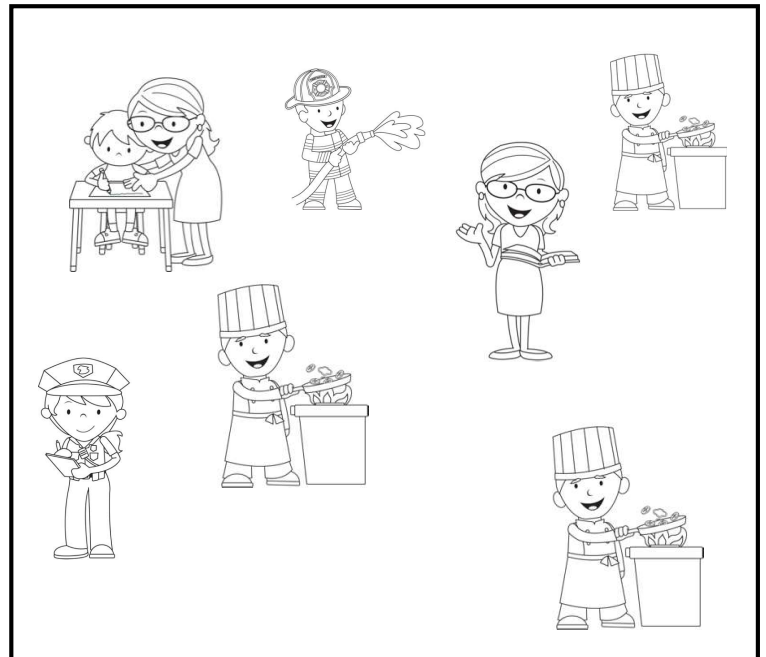
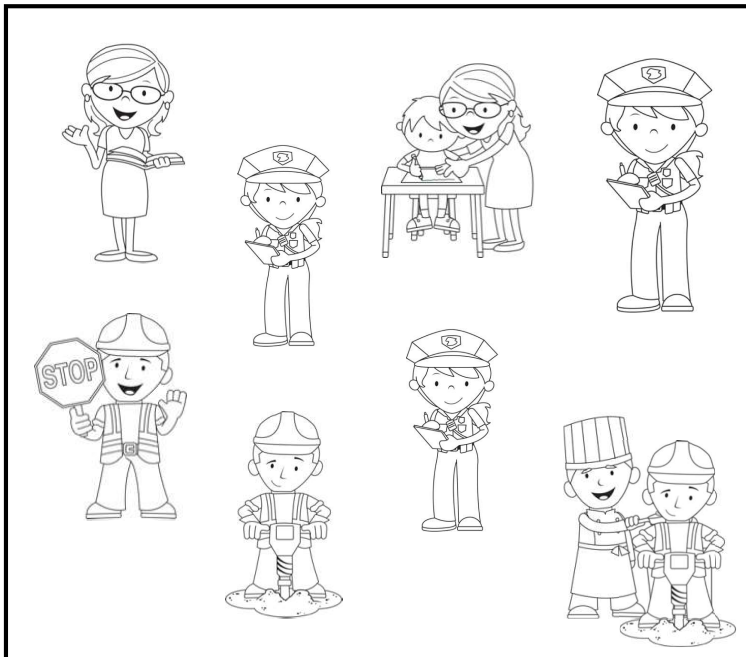

Match the pictures:

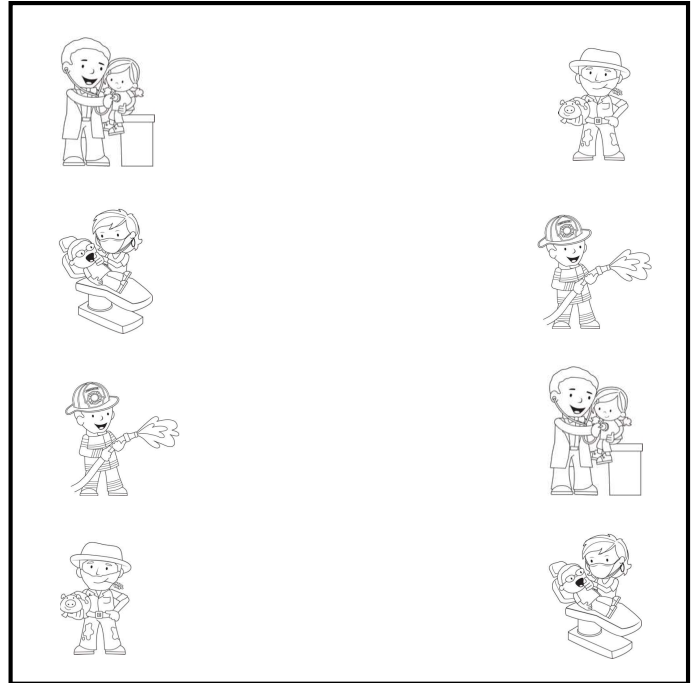
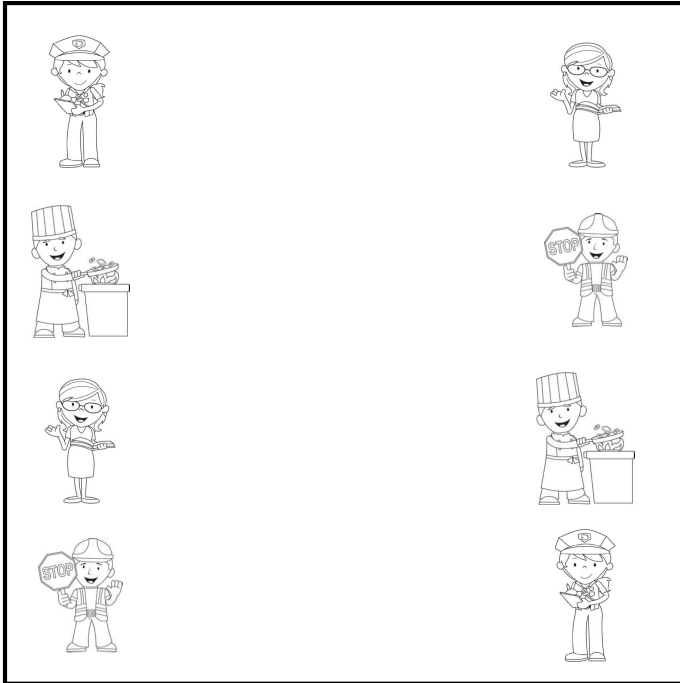

Write the words:



police officer



chef



teacher



construction worker



fire fighter

chef



police officer



teacher



construction worker



fire fighter



Match the pictures:

Write **water**, **land**, or **air** under each set of items:

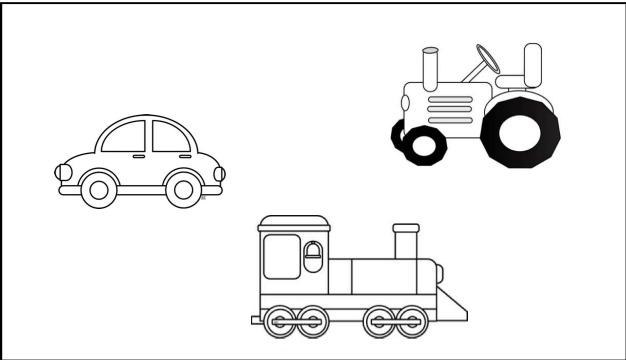
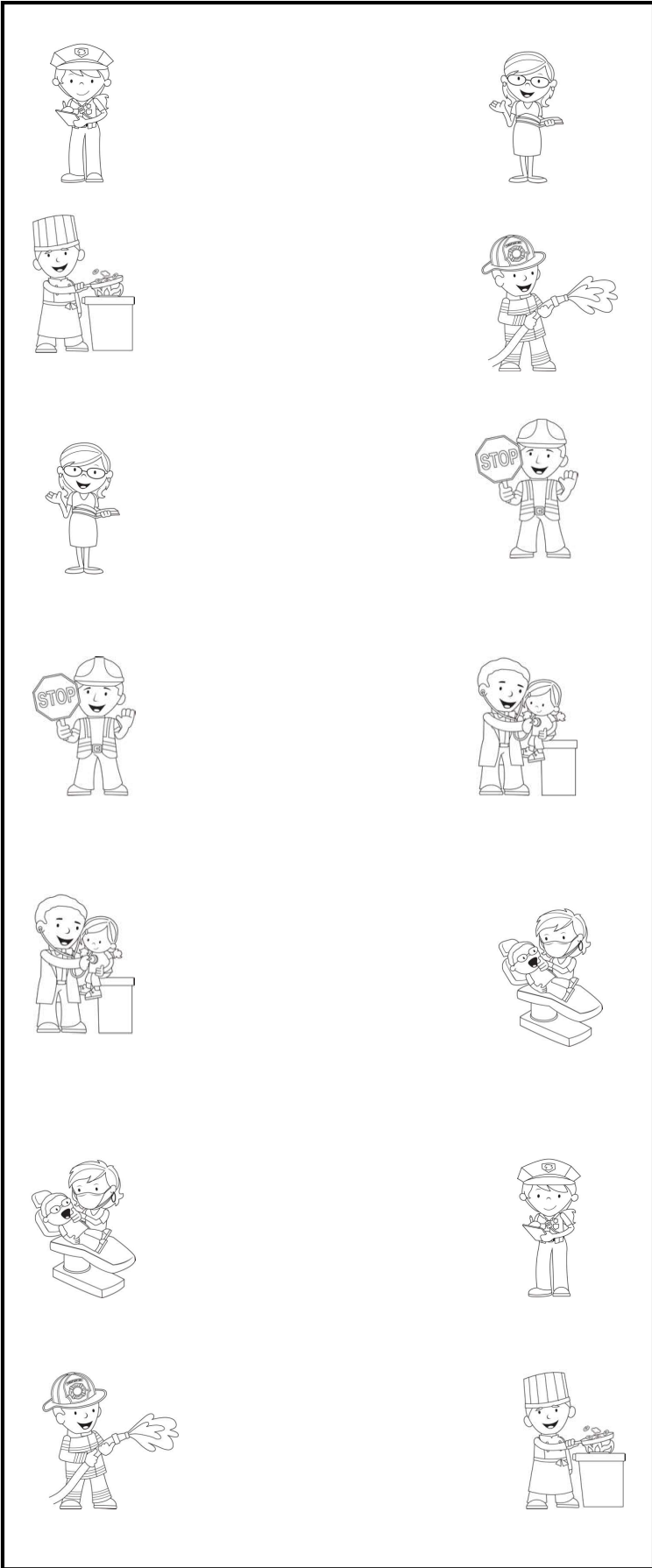

land

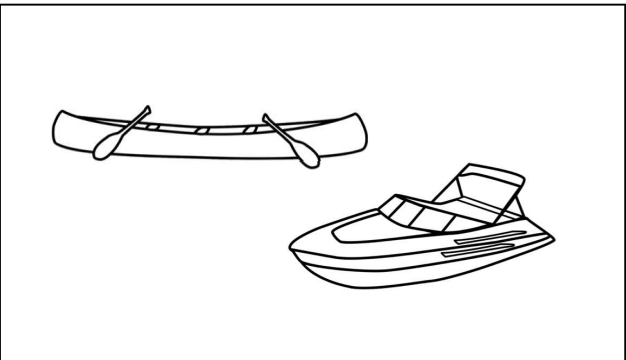

water

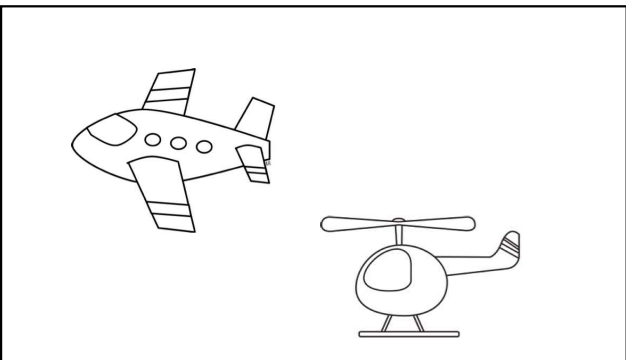

air

Color all the of the fire fighters:



Copy the name of each:

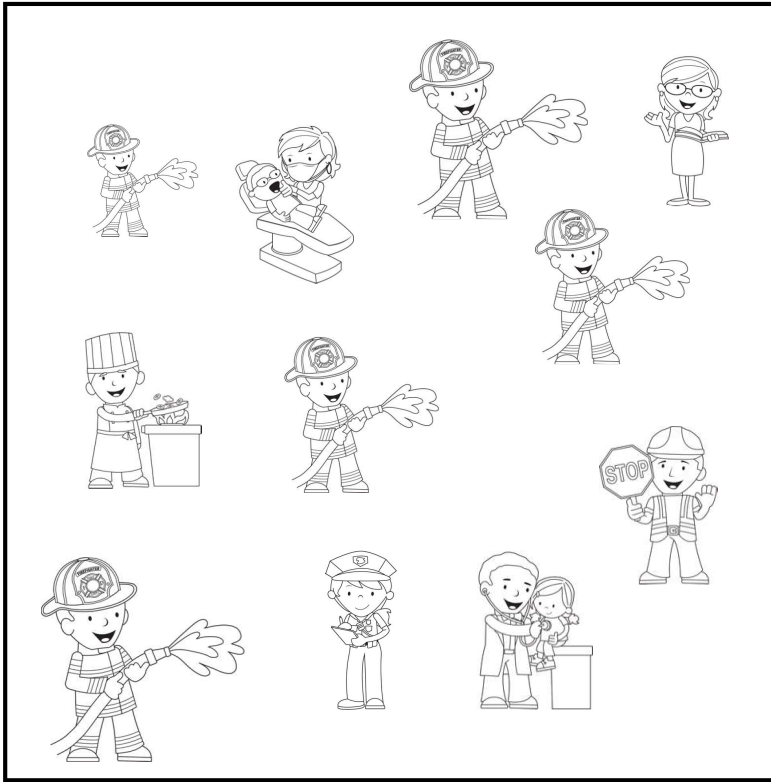

teacher: teacher

chef: chef

doctor: doctor

farmer: farmer

Match the pictures:

Match the pictures:

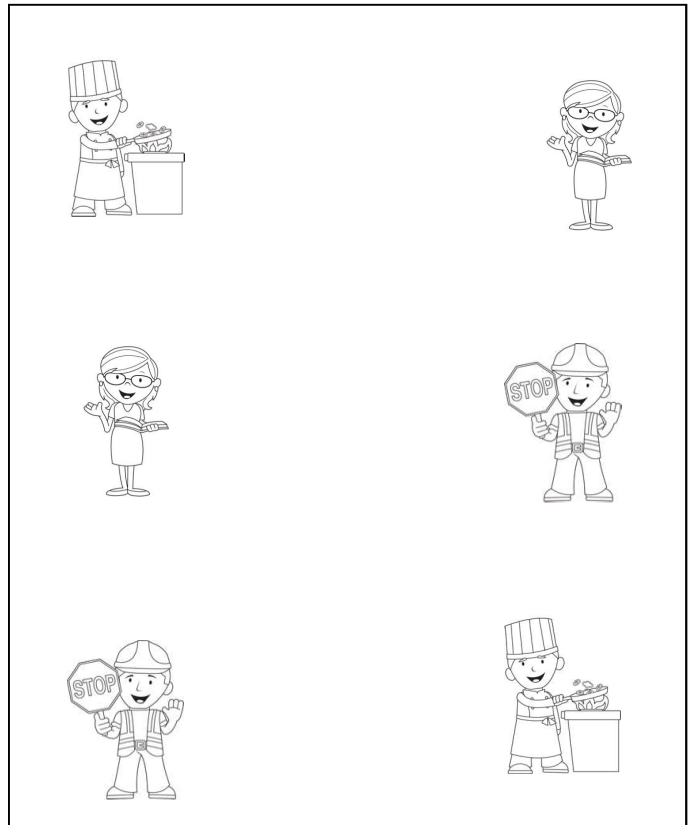
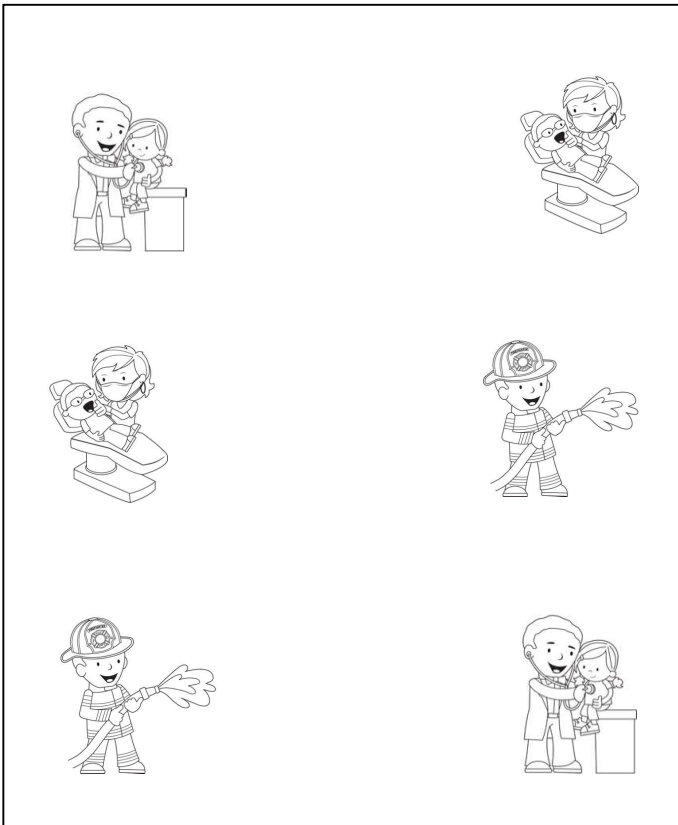

Circle the correct word:



farmer  
chef



chef  
doctor







police officer  
fire fighter



teacher  
dentist

Copy each word:

<p>teacher </p> <p>teacher</p>	<p>police officer </p> <p>police officer</p>
<p>construction worker </p> <p>construction worker</p>	<p>chef </p> <p>chef</p>

Circle the correct name of each item:



police officer    chef



doctor    chef



chef    dentist



farmer    chef





teacher    dentist



doctor    fire fighter

Color the chef **orange**:

Color the construction worker **green**:



Write the name of each:

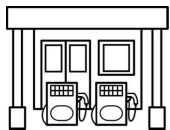

gas station

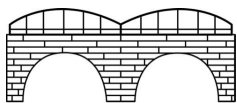

bridge



fire station



post office

Copy each word:

**chef**



chef

**farmer**



farmer

**doctor**



doctor

**dentist**



dentist



Write the community helper under each group of pictures:



farmer

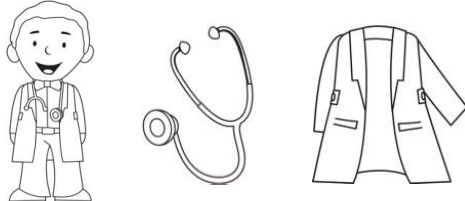

doctor

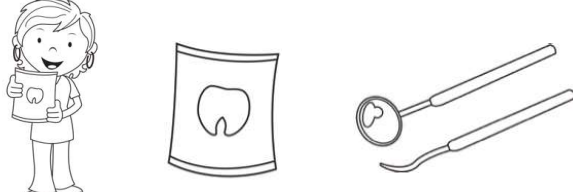

dentist

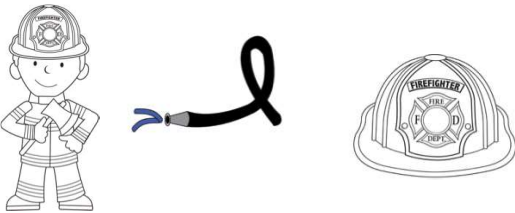

fire fighter

Match the community helper to the word:



dentist



police officer



chef



doctor



fire fighter



teacher















construction worker



farmer

Match the community helper to something they use:

Match the community helper to something they use:

	chef doctor
---	----------------

	dentist chef
--	-----------------

	teacher fire fighter
---	-------------------------

	fire fighter doctor
--	------------------------

	construction worker dentist
---	--------------------------------

	farmer teacher
--	-------------------

Color the dentist blue;  
Color the fire fighter red;  
Color the chef yellow;  
Color the police officer green:



Color the items for each community helper:

What does a police officer need?

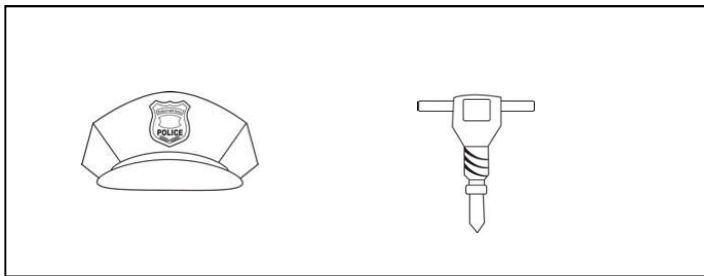

What does a doctor need?

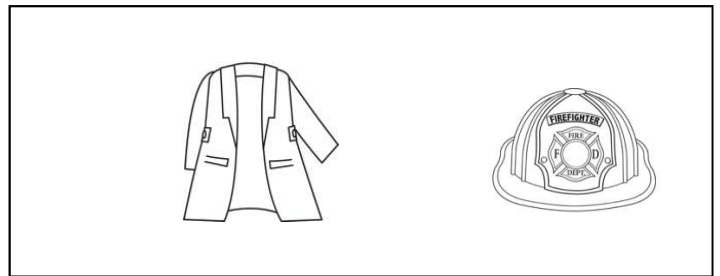



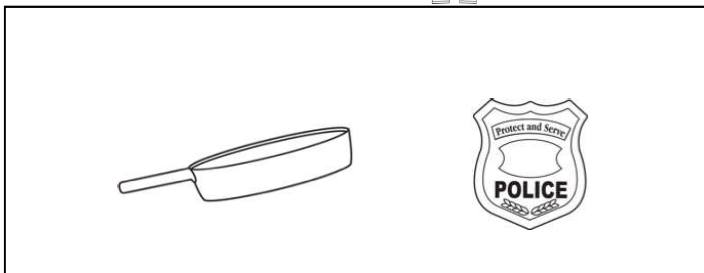

What does a chef need?

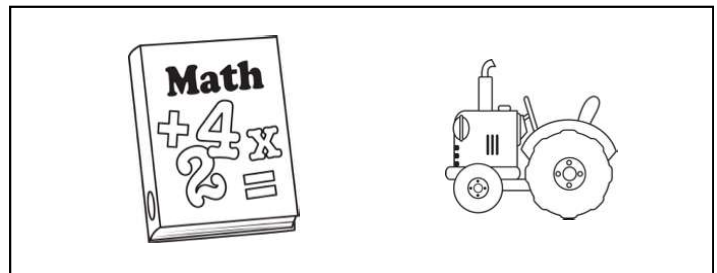



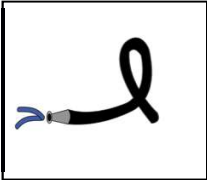

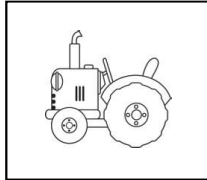
What does a farmer need?















What does each community helper use?

  	  	  
---	---	--

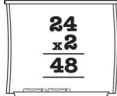



Color the match:

				
--	---	---	---	---

Match the community helper to something they use:

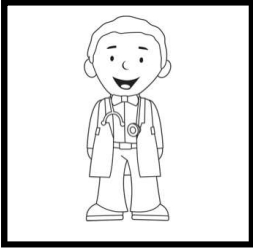
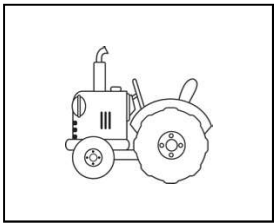
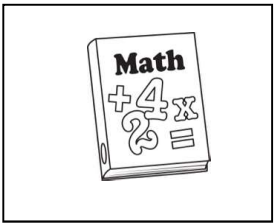
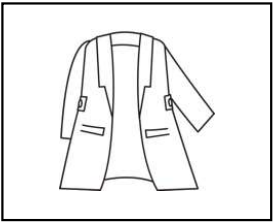
Circle the match of the association:

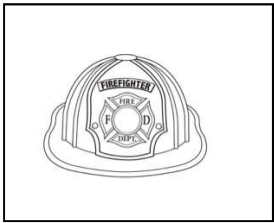
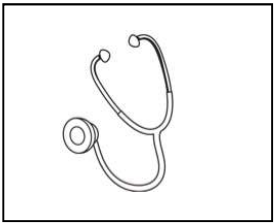
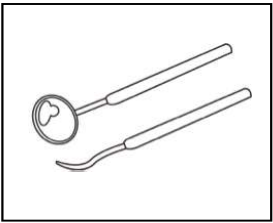
Write the words:

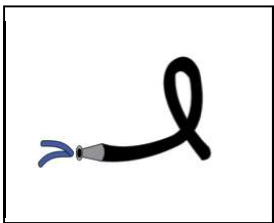
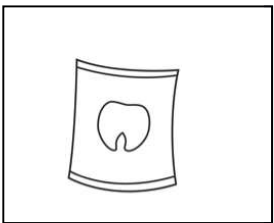
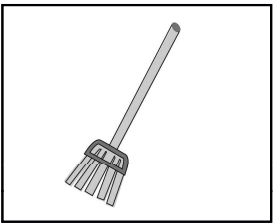

globe

---



compass

---



street

---

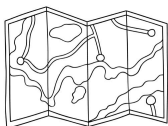

map

---

**globe**



**compass**



**map**

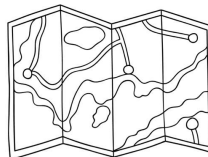

**street**

---

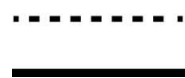

Circle the correct name of each item:



farmer    chef



teacher    dentist



doctor    fire fighter



police officer    chef











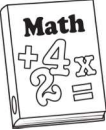

doctor    chef





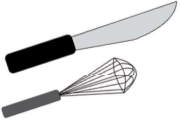







chef    dentist



Match the community helper to something they use:

Match the community helper to the word:

	doctor		dentist
	construction worker		construction worker
	police officer		doctor
	teacher		farmer
	chef		fire fighter

What does each community helper use?

Circle the two that go together:

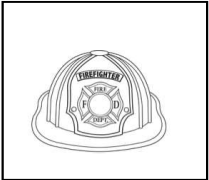
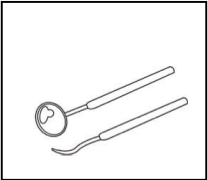
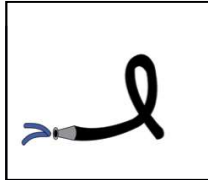
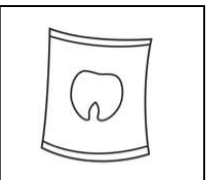
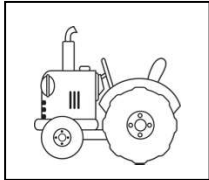
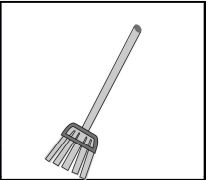

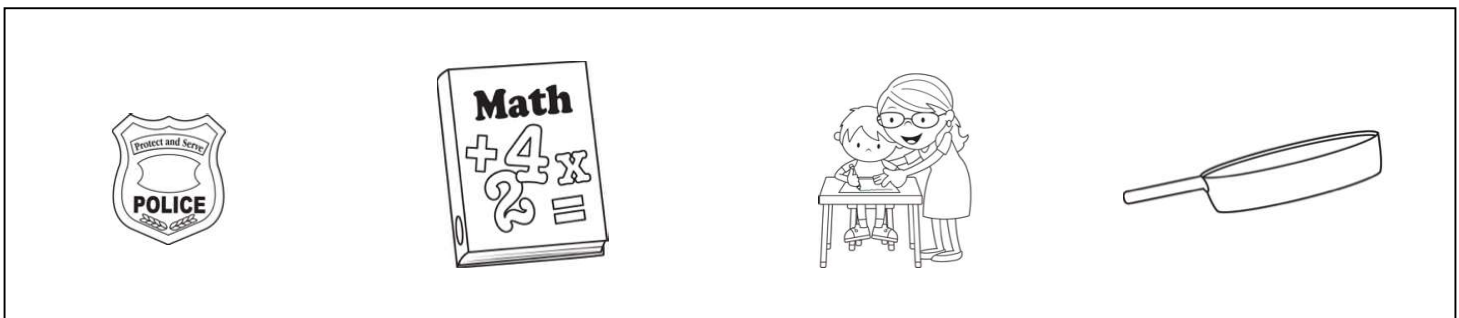
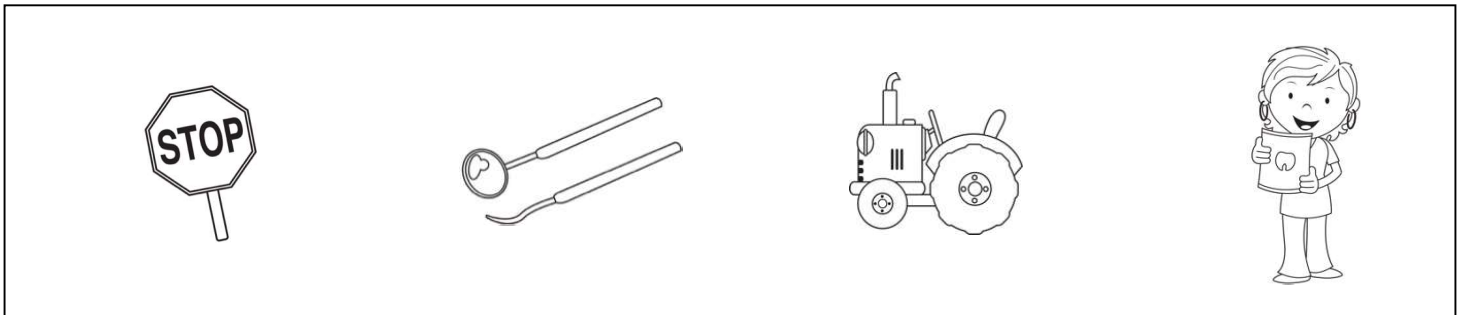
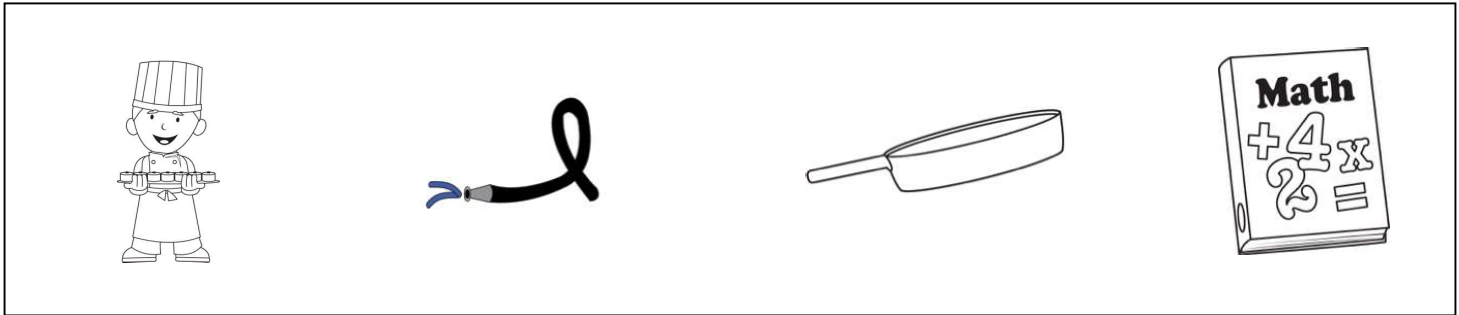
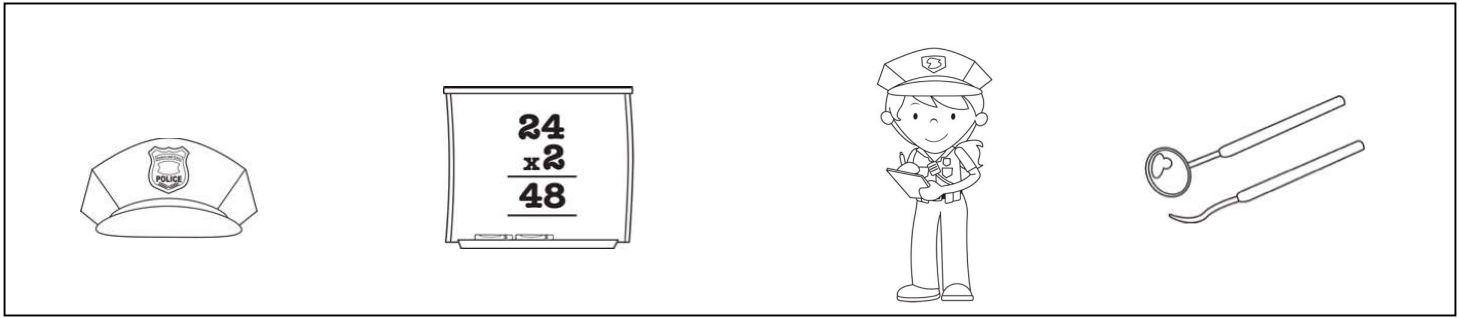
Color all the of the gas stations:



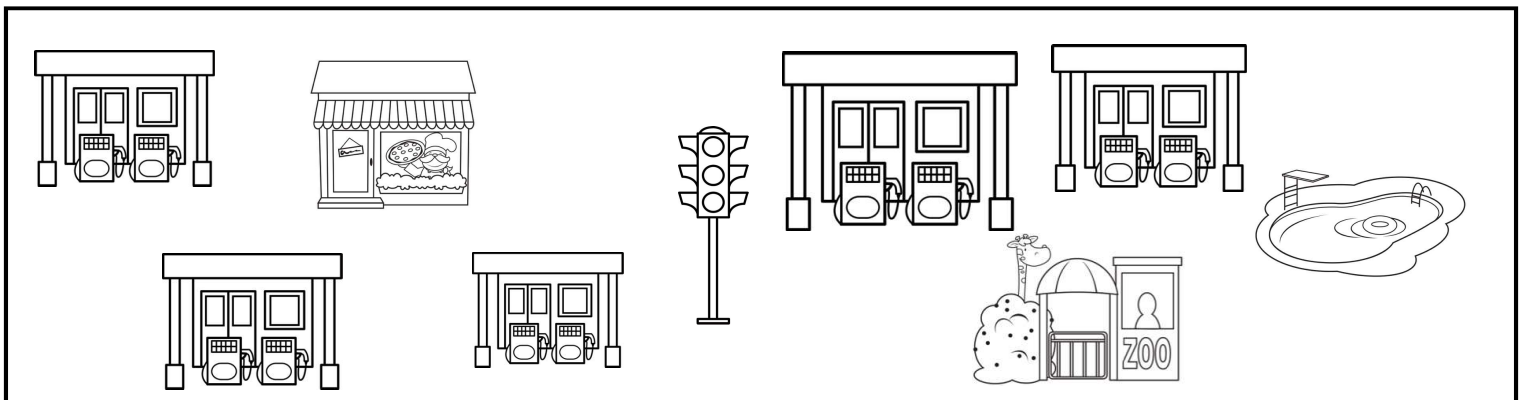
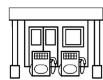

Color the items for each community helper:

What does a chef need?

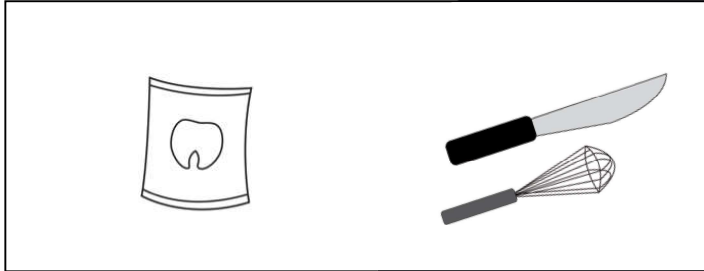

What does a dentist need?

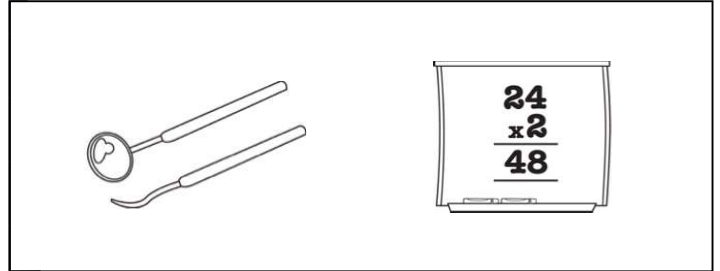

What does a teacher need?

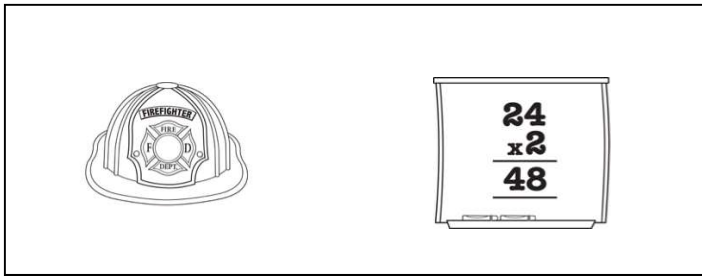

What does a fire fighter need?

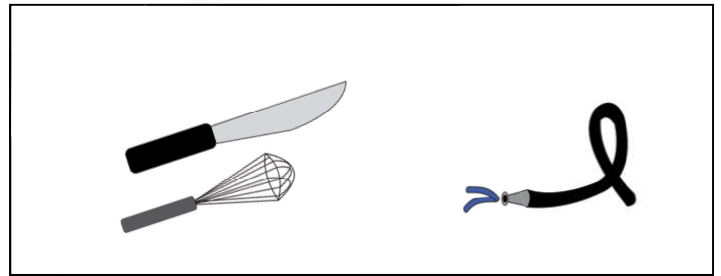

Color all the of the things a chef uses:

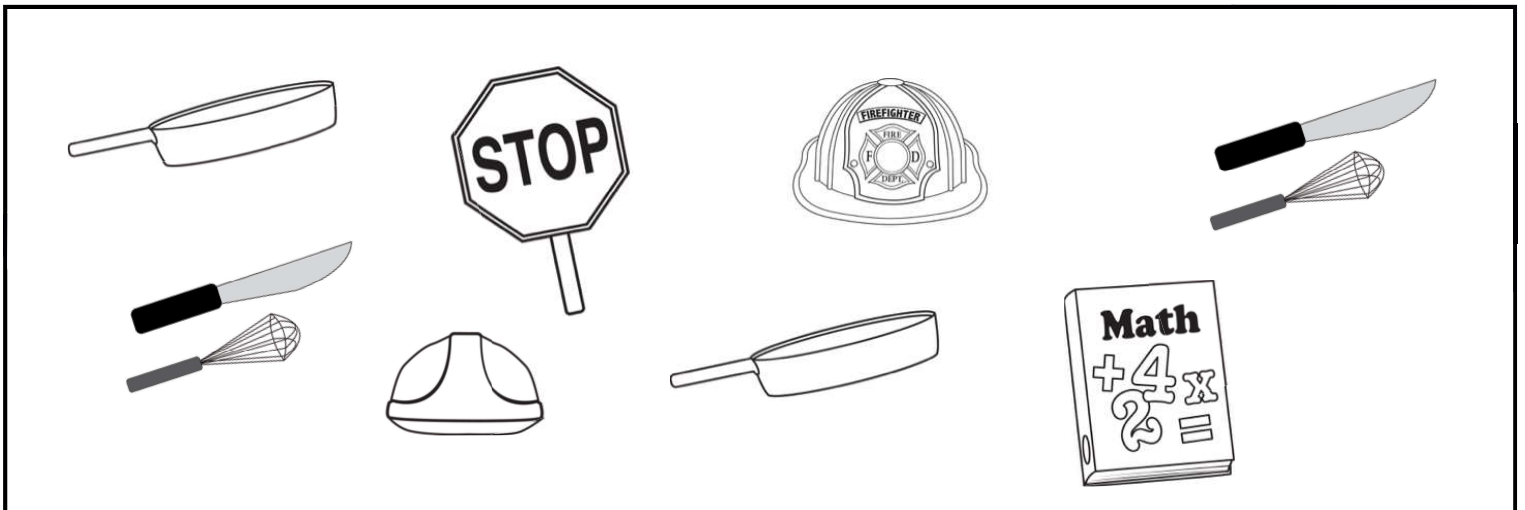

Copy the name of each:

teacher: teacher

farmer: farmer

Match the community helper to something they use:

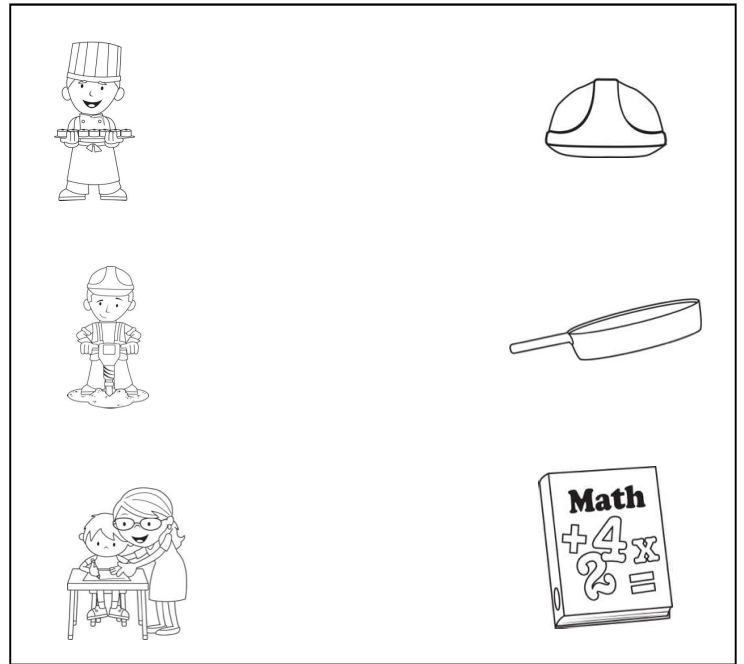
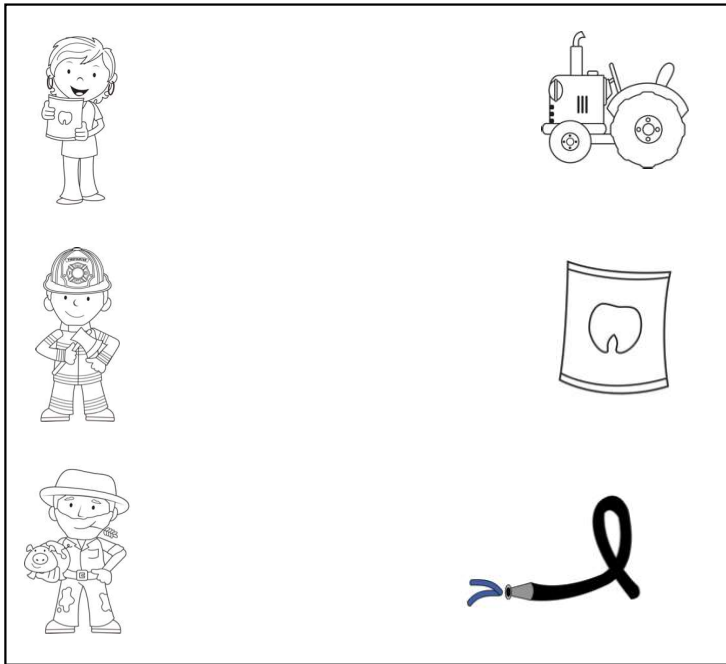

Circle the correct word:



doctor  
dentist



teacher  
fire fighter



teacher  
chef



police officer  
fire fighter



doctor  
farmer



construction worker  
doctor

Write the name of each:



doctor



fire fighter



teacher

Match the community helper to the word:



doctor



construction worker



fire fighter



chef



teacher



police officer











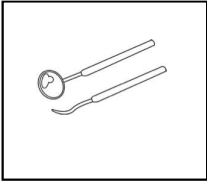
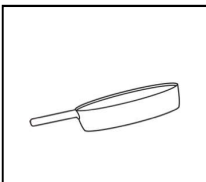

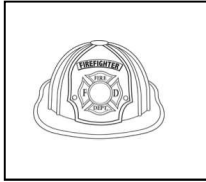
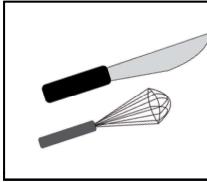
dentist

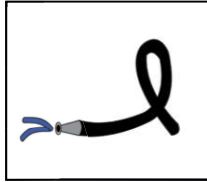
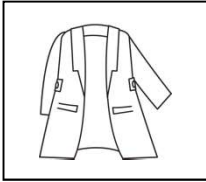

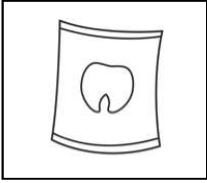
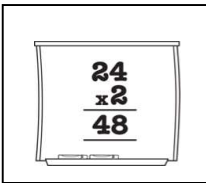
teacher

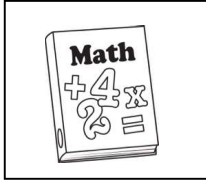
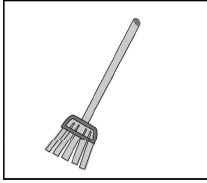
What does each community helper use?

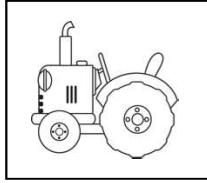
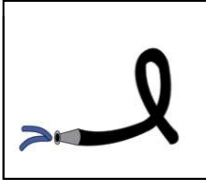
Circle the correct name of each item:



White House  
Washington, D.C.

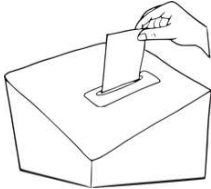

flag  
vote



Washington, D.C.  
White House